

Mathematical model for control of tuberculosis epidemiology

by Hasan S. Panigoro

Submission date: 09-May-2023 10:20PM (UTC+0800)

Submission ID: 2088587394

File name: Mathematical_model_for_control_of_tuberculosis_epidemiology.pdf (909.25K)

Word count: 7829

Character count: 38208



Mathematical model for control of tuberculosis epidemiology

Mayowa M. Ojo^{1,2} · Olumuyiwa James Peter³ ·
Emile Franc Doungmo Goufo² · Hasan S. Panigoro⁴ ·
Festus Abiodun Oguntolu⁵

Received: 25 February 2022 / Revised: 26 March 2022 / Accepted: 31 March 2022

© The Author(s) under exclusive licence to Korean Society for Informatics and Computational Applied Mathematics 2022

Abstract

Tuberculosis is an infectious disease caused by bacteria that most commonly affects the lungs. Due to its high mortality, it remains a global health issue, and it is one of the leading causes of death in the majority of sub-Saharan African countries. We formulate a six-compartmental deterministic model to investigate the impact of vaccination on the dynamics of tuberculosis in a given population. The qualitative behaviors of the presented model are examined, and the respective threshold quantity was obtained. The tuberculosis-free equilibrium of the system is said to be locally asymptotically stable when the effective reproduction number $\mathcal{R}_0 < 1$ and unstable otherwise. Furthermore, we examined the stability of the endemic equilibrium, and the conditions for the existence of backward bifurcation are discussed. A numerical simulation was performed to demonstrate and support the theoretical findings. The result shows that reducing the effective contact with an infected person and enhancing the rate of vaccinating susceptible individuals with high vaccine efficacy will reduce the burden of tuberculosis in the population.

Keywords Tuberculosis model · Effective reproduction number · Stability analysis · Bifurcation analysis

Mathematics Subject Classification 91A40 · 34D23

✉ Olumuyiwa James Peter
peterjames4real@gmail.com

¹ Microbiology Division, Thermo Fisher Scientific, Lenexa, KS, USA

² Department of Mathematical Sciences, University of South Africa, Florida, South Africa

³ Department of Epidemiology and Biostatistics, School of Public Health, University of Medical Sciences, Ondo City, Ondo State, Nigeria

⁴ Department of Mathematics, State University of Gorontalo, Bone Bolango 96119, Indonesia

⁵ Department of Mathematics, Federal University of Technology, Minna, Niger State, Nigeria

Published online: 22 April 2022

Springer

4 1 Introduction

Tuberculosis (TB) is a contagious illness that primarily affects the lungs but can affect any organ in the body [1]. The Bacteria can spread by droplets in the air, causing them to develop. Although tuberculosis can be deadly, it is often prevented and treated. About a quarter of the world's population has a tuberculosis infection, which means they've been infected with the germs but aren't symptomatic yet and can't spread it. When an infected individual coughs or sneezes, the bacterium that causes tuberculosis is disseminated [2, 3]. The majority of people who are infected with the bacteria that causes tuberculosis don't show any signs or symptoms. When symptoms do appear, they typically include a cough (which can be bloody), weight loss, nocturnal sweats, and a fever [4, 5]. A person can have tuberculosis bacteria in their body but not develop symptoms. Most people's immune systems are capable of containing bacteria, preventing them from replicating and causing disease. A person will have a TB infection but not an active disease in this case. This is referred to as latent tuberculosis (TB). The body's ability to contain tuberculosis bacteria may be compromised. When the immune system is weak by disease or the use of certain medications, this is more likely to occur. When this occurs, the bacteria can multiply and create symptoms, leading to active tuberculosis. People who have active tuberculosis can spread the infection to others. Treatment isn't usually necessary for people who don't have any symptoms. Active symptoms will require a long course of antibiotic treatment using various medications. To effectively control and prevent infectious diseases such as tuberculosis, one must be well-versed in the disease's spread mechanism and transmission dynamics. This will aid our disease prediction and elimination tactics. Because diseases vary over time, studying epidemic dynamics is an important theoretic way to obtain insight into their transmission dynamics and control. Mathematical models are often used to better understand how infectious diseases spread and how to prevent them [6]. Several research have been conducted utilizing a mathematical model method in order to identify ways to control diseases in the population [7–22]. Many models on the dynamics of tuberculosis have been developed and examined to gain a better knowledge of the transmission dynamics and control of tuberculosis. Yang et al. [23] developed a model to investigate the role of partial therapy in the transmission of tuberculosis disease. Zhang et al. [24] examined a dynamical TB illness problem involving both hospitalized and non-hospitalized infectious classes. Egwagan and Daniel [25] also presented a model for tuberculosis disease to estimate the impact of treatment and analysis for infectious individuals. The stability of tuberculosis with partial treatment is investigated by Ullah et al. [26]. Intan et al. [27] investigated tuberculosis transmission by taking into account the existence of a latent group and vaccine administration to the susceptible class. The model was constructed using the SEIR approach, and the results indicated that increasing the vaccination rate would reduce the rate of TB disease transmission. Several researchers have proposed mathematical models for tuberculosis to investigate the disease's global stability and the impact of heterogeneity on TB dispersion [28, 29]. Other significant contributions on the dynamics of TB models can be found in [30–36]. Few works in the literature focused on deterministic modelling of tuberculosis disease inspired us. Each of these research is based on deterministic models, however, none of the studies examine the role of vaccination, contact rate,

vaccine efficiency, or coverage rate in disease control. Vaccination is the most effective way to reduce the burden of disease in a population. It's a long-standing prevention strategy for a variety of diseases, including tuberculosis. This protects the population from infection and reduces the number of potential infections in the community. As a result, this study aims to investigate the effects of vaccination of susceptible individuals, vaccine efficacy, and contact rate on the transmission dynamics of tuberculosis. We believe that the study will provide governments and the public health sector with information on how to prevent the disease from spreading. This paper is organized as follows: Sect. 2 deals with the formulation of the model, the basic properties of the model are derived in Sect. 3, Numerical results and discussion of the analytical findings and conclusion are presented in Sects. 4 and 5 respectively.

2 Model formulation

In this section, we propose a deterministic model of tuberculosis (TB) which comprises six compartments based on the epidemiological status of individuals in the population. The compartments include the susceptible population $S(t)$ (these are individuals who are prone or susceptible to TB), the vaccinated population $V(t)$, latent population $L(t)$ (these are individuals who are infected with TB without showing any symptoms), the active TB population $A(t)$ (these are TB infected individuals that are showing symptoms of the disease), the treated population $T(t)$, and the recovered population $R(t)$ (these are individuals that have been treated and free of TB). Thus, the total population represented by $N(t)$ is the sum of all the compartment given as $N(t) = S(t) + V(t) + L(t) + A(t) + T(t) + R(t)$. We assume that the susceptible population is derived by the recruitment rate through birth or immigration at a rate θ , and vaccine wane at rate ρ . This population is depopulated by the effective contact with an infected individual at a rate ω . We assume that only the active TB individuals can transfer the infection, thus the force of infection is given as ωSA . The susceptible population is further reduced through vaccination at the rate τ , and natural death μ . Thus, the susceptible population is given as

$$\theta + \rho V - \omega SA - (\mu + \tau)S$$

Following vaccination, the susceptible individuals are partially protected from being infected with TB and thus increase the vaccinated population at the rate τ . The partial protection from vaccination is a result of the use of an imperfect vaccine. Thus, we assume that the vaccinated individuals can be infected at an effective contact with an active TB individual at a reduced rate of $(1 - \varepsilon)$ so that the force of infection for the vaccinated population is given as $(1 - \varepsilon)VA$. Furthermore, the population is reduced by the vaccine waning rate and natural death at the rate ρ and μ respectively. So, the vaccinated population is given as

$$\theta + \rho V - \omega SA - (\mu + \tau)S.$$

The latent class is populated by the infection rate from the susceptible and the vaccinated class. This population is reduced by the natural mortality at the rate μ , and by the progression rate of latent to active TB stage at the rate β . Hence, the latent population is given as

$$\omega SA + \omega(1 - \varepsilon)VA - (\beta + \mu)L.$$

After the incubation period, the latent individuals will start showing symptoms of TB and thus progress to increase the active TB population at the rate β . This population is reduced by natural death μ , disease-induced death δ (the death due to tuberculosis), and the treatment rate γ . Consequently, the active TB population is given as

$$\beta L - (\mu + \delta + \gamma)A.$$

Following the treatment of the active TB individuals, they progress to the treated class at the rate γ . This population is decreased by the natural death μ , and the recovery rate ϕ . It must be noted that in this work, we do not consider the case of treatment failure, thus the treated population is given as

$$\gamma A - (\mu + \phi)T.$$

Lastly, the recovered class is populated by the recovery rate of treated individuals at the rate ϕ , while it is depopulated by the natural death at rate μ . Thus, the recovered population is given as

$$\phi T - \mu R.$$

Following the above descriptions, the six compartmental deterministic models used in studying the dynamics of TB in this study are represented in the form of nonlinear differential equations below.

$$\begin{aligned} \frac{dS}{dt} &= \theta + \rho V - \omega SA - (\mu + \tau)S, \\ \frac{dV}{dt} &= \tau S - \omega(1 - \varepsilon)VA - (\mu + \rho)V, \\ \frac{dL}{dt} &= \omega SA + \omega(1 - \varepsilon)VA - (\beta + \mu)L, \\ \frac{dA}{dt} &= \beta L - (\mu + \delta + \gamma)A, \\ \frac{dT}{dt} &= \gamma A - (\mu + \phi)T, \\ \frac{dR}{dt} &= \phi T - \mu R. \end{aligned} \tag{1}$$

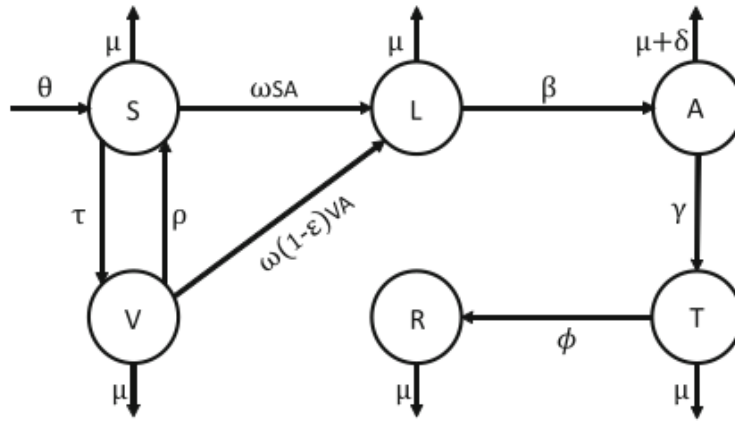

Fig. 1 Schematic illustration of the TB model (1)

Table 1 Description of the model variables

| Variable | Description |
|----------|-------------------|
| $S(t)$ | Susceptible class |
| $V(t)$ | Vaccinated class |
| $L(t)$ | Latent class |
| $A(t)$ | Active TB class |
| $T(t)$ | Treated class |
| $R(t)$ | Recovered class |

Table 2 The description of parameters and values

| Parameter | Description | Value | Source |
|---------------|---|------------------|----------|
| θ | Recruitment rate into susceptible class | 5 | [37] |
| ρ | Vaccine wane rate | 0.067, 0.1 | [38–41] |
| ω | Effective contact rate | 0.6501 | [4] |
| τ | Rate of vaccinating susceptible individuals | 0.1–0.98 | [25, 42] |
| ε | Vaccine efficacy | 0–1 | [43, 44] |
| γ | Rate of treatment for active TB individuals | 0.1 | [4] |
| ϕ | Recovery rate of treated individuals | 0.01 | [4] |
| μ | Natural death rate | $\frac{1}{67.7}$ | [4] |
| δ | TB induced death rate | 0.1 | [4] |
| β | Progression rate from latent to active TB | 0.00375 | [42] |

With the initial conditions $S(0) > 0, V(0) \geq 0, L(0) \geq 0, A \geq 0, T(0) \geq 0$, and $R \geq 0$. The description of the model variables and parameters are presented in Tables 1 and 2 respectively, while the pictorial illustration is given in Fig. 1.

3 Model analysis

In this section, we study the positivity and boundedness of the solutions, investigate the existence and stability of the steady states (disease-free equilibrium and endemic equilibrium). In addition, we examine the nature of bifurcation exhibited by the model (1). Furthermore, we investigate the impact of vaccine efficacy and proportion of vaccinated individuals in controlling the disease burden by using the threshold quantities. Lastly, we examine the nature of bifurcation exhibited by the TB model.

3.1 Positivity and boundedness of solutions

For the TB model (1) to be epidemiologically meaningful, it is important to show that its state variables are non-negative for all time $t > 0$ and that the feasible region Ω is bounded. Therefore, we state the following result.

Theorem 1 *The initial data for the TB model satisfies $S(0) > 0, V(0) \geq 0, L(0) \geq 0, A(0) \geq 0, T(0) \geq 0,$ and $R(0) \geq 0,$ such that the solutions of the model represented by $(S(t), V(t), L(t), A(t), T(t), R(t))$ with positive initial data remain positive for all time $t > 0.$*

Proof Let $t_f = \sup\{t > 0 : S(t) > 0, V(t) > 0, L(t) > 0, A(t) > 0, T(t) > 0, R(t) > 0 \in [0, t]\},$ so that $t_f > 0.$ Considering the first equation of the model presented in (1), it follows that

$$\frac{dS}{dt} = \theta + \rho V - \omega SA - (\mu + \tau)S \geq \theta - \lambda_* S - (\mu + \tau)S, \tag{2}$$

where $\lambda_* = \omega A.$ We employ the integrating factor method to solve the ordinary differential equation given in (2). Thus, this is expressed as

$$\frac{d}{dt} \left(S(t) \exp \left[(\mu + \tau)t + \int_0^t \lambda_*(\zeta) d\zeta \right] \right) \geq \theta \exp \left[(\mu + \tau)t + \int_0^t \lambda_*(\zeta) d\zeta \right].$$

Hence,

$$\begin{aligned} & S(t_f) \exp \left[(\mu + \tau)t_f + \int_0^{t_f} \lambda_*(\zeta) d\zeta \right] - S(0) \\ & \geq \int_0^{t_f} \theta \left(\exp \left[(\mu + \tau)\eta + \int_0^\eta \lambda_*(\zeta) d\zeta \right] \right) d\eta \end{aligned}$$

so that,

$$\begin{aligned} S(t_f) & \geq S(0) \exp \left[-(\mu + \tau)t_f - \int_0^{t_f} \lambda_*(\zeta) d\zeta \right] + \exp \left[-(\mu + \tau)t_f - \int_0^{t_f} \lambda_*(\zeta) d\zeta \right] \\ & \quad \times \int_0^{t_f} \theta \left(\exp \left[(\mu + \tau)\eta + \int_0^\eta \lambda_*(\zeta) d\zeta \right] \right) d\eta > 0. \end{aligned}$$

Clearly, from (37) the above inequality $S(t_f) \geq 0$ is positive. Similarly, the remaining state variables $V(t) \geq 0$, $L(t) \geq 0$, $A(t) \geq 0$, $T(t) \geq 0$, and $R(t) \geq 0$, can be shown to be positive for all time $t > 0$. Thus, all the solutions of the TB model (1) remain positive for all positive initial conditions. \square

Furthermore, for the TB model (1) to be mathematically and epidemiologically meaningful, it is essential to consider system (1) in a biologically feasible region $\Omega \subset \mathcal{R}_+^6$ such that

$$\Omega = \left\{ (S, V, L, A, T, R) \in \mathcal{R}_+^6 : S + V + L + A + T + R \leq \frac{\theta}{\mu} \right\}.$$

Employing the standard technique method as presented in [45], the feasible region Ω can be shown to be positively invariant. Thus, all the solutions $(S(t), V(t), L(t), A(t), T(t), R(t))$ are in the feasible region Ω where the TB model is said to be mathematically and epidemiologically well-posed [45, 46]. Hence, we claim the following result in the theorem below.

Theorem 2 *The biological feasible region $\Omega \subset \mathcal{R}_+^6$ of the TB model presented in (1) is positively invariant with positive initial conditions in \mathcal{R}_+^6 .*

3.2 Existence and stability of the TB-free equilibrium (TBFE)

The disease-free equilibrium steady state henceforth refers to as TB-free equilibrium steady state (TBFE) describes the state at which the population is free from the presence of TB infection. To obtain the TBFE, we equate the right hand side of all the equations in (1), and the variables L, A to zero. Thus, the TB-free equilibrium denoted by \mathcal{E}_0 is obtained as

$$\begin{aligned} \mathcal{E}_0 &= (S^*, V^*, L^*, A^*, T^*, R^*), \\ &= \left(\frac{\theta(\mu + \rho)}{\mu(\mu + \rho + \tau)}, \frac{\theta\tau}{\mu(\mu + \rho + \tau)}, 0, 0, 0, 0 \right). \end{aligned} \tag{3}$$

We further obtain the threshold quantity called the reproduction number to investigate the stability of the system. This is achieved by using the next-generation matrix method as presented in [47, 48]. Consequently, the Jacobian matrix of the new infection terms (F) and the remaining transfer terms (V) are obtained as

$$F = \begin{bmatrix} 0 & \omega[S + (1 - \varepsilon)V] \\ 0 & 0 \end{bmatrix} \text{ and } V = \begin{bmatrix} \beta + \mu & 0 \\ -\beta & \mu + \delta + \gamma \end{bmatrix}$$

Hence, follow [50] [45], the reproduction number of the model (1) defined as the highest eigenvalue of FV^{-1} given by $\mathcal{R}_0 = \rho(FV^{-1})$, is obtained as

$$\mathcal{R}_0 = \frac{\beta\omega\theta[(\mu + \rho) + (1 - \varepsilon)\tau]}{\mu(\mu + \rho + \tau)(\beta + \mu)(\mu + \delta + \gamma)}. \tag{4}$$

The threshold quantity \mathcal{R}_0 given in (4) is known as the effective reproduction number, also called the control reproduction number. It measures the average number of new secondary infections a single infected individual can reproduce during an infection period, in a population that is completely susceptible in the presence of control measures (in this case vaccination) [49]. Thus, the threshold quantity \mathcal{R}_0 in (4) measures the expected number of new TB cases that one TB-infected person can produce in a completely susceptible population in a population with a vaccination program. A similar threshold quantity identified as the basic reproduction number can be gotten by setting the control measure and its parameters into zero (i.e $\rho = \tau = \varepsilon = 0$), such that

$$\mathcal{R}_\Delta = \frac{\beta\omega\theta}{\mu(\beta + \mu)(\mu + \delta + \gamma)}. \tag{5}$$

It must be noted that the basic reproduction number \mathcal{R}_Δ measures the average number of secondary cases produced by a single infected individual in a population that is completely susceptible, in a population without any control measure (see, for examples [8, 50–54]). Now, following Theorem 2 of [55], we use the effective reproduction number \mathcal{R}_0 to establish the local stability of the TB-free equilibrium \mathcal{E}_0 , and the result is given in the Theorem below.

Theorem 3 The TB-free equilibrium \mathcal{E}_0 , the model (1) is locally asymptotically stable in the biological feasible region Ω if $\mathcal{R}_0 < 1$ and unstable if $\mathcal{R}_0 > 1$.

Proof To prove Theorem 3 above, we obtained the Jacobian matrix of system (1) at the TB free-equilibrium \mathcal{E}_0 as

$$\mathcal{J}(\mathcal{E}_0) = \begin{bmatrix} -k_1 & \rho & 0 & -\omega S^* & 0 & 0 \\ \tau & -k_2 & 0 & -\omega k_6 V^* & 0 & 0 \\ 0 & 0 & -k_3 & \omega(S^* + k_6 V^*) & 0 & 0 \\ 0 & 0 & \beta & -k_4 & 0 & 0 \\ 0 & 0 & 0 & \gamma & -k_5 & 0 \\ 0 & 0 & 0 & 0 & 0 & -\mu \end{bmatrix} \tag{6}$$

where $k_1 = \mu + \tau$, $k_2 = \mu + \rho$, $k_3 = \beta + \mu$, $k_4 = \mu + \delta + \gamma$, $k_5 = \mu\phi$, and $k_6 = 1 - \varepsilon$, while S^* and V^* are steady states given in (3). To establish the stability of the TB-free equilibrium, it is vital to show that the eigenvalues of the Jacobian matrix $\mathcal{J}(\mathcal{E}_0)$ are all negative. From (6), the first two eigenvalues are obtained as $-\mu$, and $-k_5$. We further obtain the remaining four eigenvalues from the sub-matrix \mathcal{M} given below as

$$\mathcal{M} = \begin{bmatrix} \tau & \rho & 0 & -\omega S^* \\ \tau & -k_2 & 0 & -\omega k_6 V^* \\ 0 & 0 & -k_3 & \omega(S^* + k_6 V^*) \\ 0 & 0 & \beta & -k_4 \end{bmatrix} \tag{7}$$

Following the standards of the Routh–Hurwitz criterion, all the eigenvalues of the sub-matrix \mathcal{M} will be real and negative if

- (i) $\text{Tr}(\mathcal{M}) < 0$,
- (ii) $\text{Det}(\mathcal{M}) > 0$.

Using the sub-matrix (7), we obtain the following

$$\begin{aligned} \text{Tr}(\mathcal{M}) &= -(k_1 + k_2 + k_3 + k_4) < 0, \text{ and} \\ \text{Det}(\mathcal{M}) &= k_3k_4(k_1k_2 - \rho\tau)(1 - \mathcal{R}_0), \\ &= \mu k_3k_4(\tau + k_2)(1 - \mathcal{R}_0). \end{aligned}$$

Following the above results, ⁶⁴ all the eigenvalues of the sub-matrix (6) are negative real part if $\mathcal{R}_0 < 1$. Thus, the TB-free equilibrium \mathcal{E}_0 is said to be locally asymptotically stable and unstable otherwise. \square

A simple interpretation of Theorem 3 is that TB infection can ³⁸ controlled in the population if the threshold number \mathcal{R}_0 is less than unity, and the initial size of the sub-population of the system (1) are in the basin of attraction of \mathcal{E}_0 .

3.3 Analysis of vaccine impact using the threshold quantities ($\mathcal{R}_0, \mathcal{R}_\Delta$)

As stated in Theorem 3, the control of TB depends on the value of the effective reproduction number, such that the disease can be eliminated if $\mathcal{R}_0 < 1$, while TB persists in the population otherwise. However, this is not always guaranteed particularly in a system that exhibits the coexistence of two different equilibria. For instance, if the TB model (1) exhibit the phenomenon of backward bifurcation, it will imply that the epidemiological condition of having the $\mathcal{R}_0 < 1$ to eliminate TB although necessary will not be sufficient for the effective control of TB in the populace. Thus, additional measures must be embraced to mitigate the burden of the disease. The use of imperfect vaccine as a control measure has been associated with the occurrence of backward bifurcation in many studies (see for examples [56–58]). Thus, since we consider the use of an imperfect vaccine in this work, it will be useful to investigate the impact of such vaccine and the proportion of individuals that are vaccinated, on the spread of ²⁰ in the public. To accomplish this, we will investigate the impact of the proportion of the vaccinated population at the TB-free equilibrium in controlling TB in the population. To achieve this, we define the proportion of the vaccinated population to be $\psi = \frac{V^*}{N^*}$, and we further express the effective reproduction number as a function of ψ , such that

$$\mathcal{R}_0 = \mathcal{R}_\Delta \left(\frac{\mu + \rho + (1 - \varepsilon)\tau}{\mu + \rho + \tau} \right) = \mathcal{R}_\Delta(1 - \varepsilon\psi) \tag{8}$$

It must be noted that \mathcal{R}_Δ given in Eq. (5) is the basic reproduction number without control measures, while \mathcal{R}_0 is the effective or control reproduction number with an imperfect vaccine. We note that, $\mathcal{R}_0 \leq \mathcal{R}_\Delta$ is true and the equality sign is only satisfied if $\varepsilon = \tau = \rho = 0$ (i.e $\psi = 0$). It can be observed that even in the presence of imperfect vaccine, an increase in the vaccinated proportion ψ , or vaccine efficacy and coverage (i.e $\varepsilon > 0$, and $\tau > 0$), will reduce TB burden in the population. To establish the

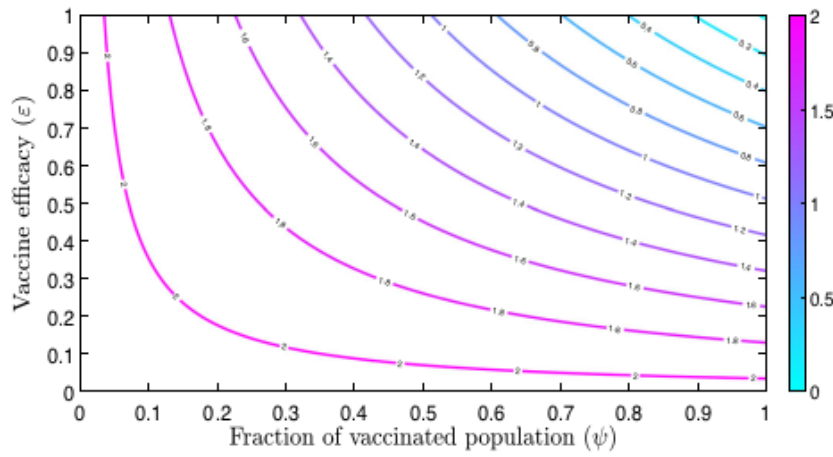

Fig. 2 Contour plot of effective reproduction number \mathcal{R}_0 as a function of the proportion of vaccinated individuals at steady-state ($\psi = \frac{V^*}{N^*}$) and vaccine efficacy ϵ . Parameter values used are as provided in Table 2

condition for which TB will be controlled based on ψ , we obtained the minimum proportion of population needed to be vaccinated as

$$\psi \geq \frac{1}{\epsilon} \left(1 - \frac{1}{\mathcal{R}_\Delta} \right) = \psi_c \tag{9}$$

such that ψ_c is the critical minimum proportion of vaccinated population needed to eliminate TB infection in the population. Consequently, following [44, 49] we establish the following theorem.

Theorem 4 *TB infection can be eliminated in the population if $\psi > \psi_c$.*

To show the impact of vaccine efficacy ϵ and proportion of vaccinated individuals at steady state ψ on the effective reproduction number, we present a contour plot of \mathcal{R}_0 as a function of ϵ and ψ in Fig. 2. From the figure, it can be deduced that to effectively control the spread of TB in the population (to attain \mathcal{R}_0), a higher proportion of vaccinated individuals must be reached with high vaccine efficacy.

3.4 Existence of endemic equilibria and backward bifurcation

We present the TB endemic equilibrium steady-state and the possibilities of backward bifurcation in this section. The TB endemic equilibria represented by $\mathcal{E}_1 = (S^{**}, V^{**}, L^{**}, A^{**}, T^{**}, R^{**})$ describes the steady-state solution in the presence of tuberculosis in the population. This equilibrium point is obtained by setting the right-hand sides of the system (1) to zero and solving simultaneously. Consequently, the result yields

$$\begin{aligned}
 S^{**} &= \frac{\theta(\omega k_6 A^{**} + k_2)}{(\omega A^{**} + k_1)(\omega k_6 A^{**} + k_2) - \rho\tau} \\
 V^{**} &= \frac{\tau\theta}{(\omega A^{**} + k_1)(\omega k_6 A^{**} + k_2) - \rho\tau} \\
 L^{**} &= \frac{\omega A^{**} [\theta(\omega k_6 A^{**} + k_2) + k_6\tau\theta]}{k_3 [(\omega A^{**} + k_1)(\omega k_6 A^{**} + k_2) - \rho\tau]} \\
 T^{**} &= \frac{\gamma A^{**}}{k_5} \\
 R^{**} &= \frac{\phi\gamma A^{**}}{\mu k_5}
 \end{aligned}
 \tag{10}$$

Since we obtained the steady states as a function of the infected variable A^{**} , we substitute the expression of L^{**} presented in (10) into the third equation of system (1) to obtain the polynomial of order two given as

$$a_1(A^{**})^2 + a_2A^{**} + a_3 = 0
 \tag{11}$$

where the polynomial coefficients a_i for $i = 1 \dots, 3$ are given as

$$a_1 = k_3k_4k_6\omega^2, \quad a_2 = \omega k_3k_4(k_2 + k_1k_6) - \beta\omega^2\theta, \quad a_3 = \mu k_3k_4(\tau + k_2)(1 - \mathcal{R}_0)$$

From the polynomial given in (11), the coefficient a_1 is positive, while the constant term a_3 is positive or negative contingent on the value of \mathcal{R}_0 . This means that, if $\mathcal{R}_0 < 1$, then a_3 is positive, while a_3 is negative if $\mathcal{R}_0 > 1$. Thus, we claim the following result.

Theorem 5 *The TB model given by Eq. (1) has*

- (i) *exactly one unique endemic equilibrium if $a_3 < 0$ or $\mathcal{R}_0 > 1$,*
- (ii) *exactly one unique endemic equilibrium if $a_2 < 0$, and either $a_3 = 0$ or $a_2^2 - 4a_1a_3 = 0$,*
- (iii) *exactly two endemic equilibria if $a_3 > 0$, $a_2 < 0$ and $a_2^2 - 4a_1a_3 > 0$,*
- (iv) *no endemic equilibrium otherwise.*

Clearly, from case (i) of Theorem 5 above, the system (1) has a unique equilibrium point represented by \mathcal{E}_1 whenever $\mathcal{R}_0 > 1$. Additionally, case (iii) of Theorem 5 shows the possibility of backward bifurcation in the TB model (1) when $\mathcal{R}_0 < 1$. Thus, in order to check for the possibility of backward bifurcation when $\mathcal{R}_0 < 1$, we set the discriminant $a_2^2 - 4a_1a_3 = 0$ and solve for the critical value of \mathcal{R}_0 which we denote by \mathcal{R}_0^c . This result to

$$\mathcal{R}_0^c = 1 - \frac{a_2^2}{4a_1\mu k_3k_4(\tau + k_2)}
 \tag{12}$$

for which we claim the following Theorem.

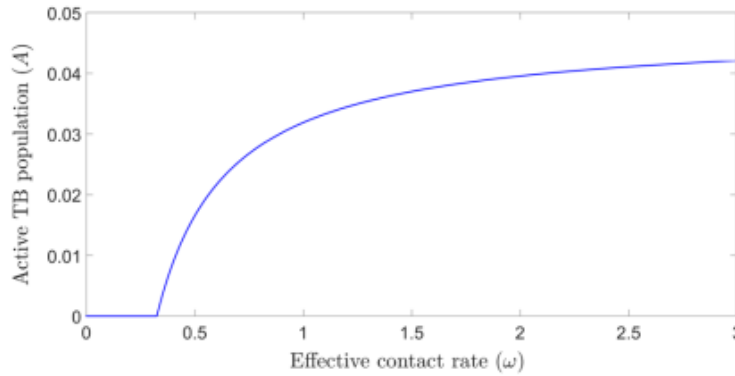

Fig. 3 Bifurcation diagram for active TB population in terms of effective contact rate $\omega \in [0, 3]$. Parameter values used are as provided in Table 2 69

Theorem 6 *The TB model (1) will exhibit a backward bifurcation when case (iii) of Theorem 5 holds and the inequality $\mathcal{R}_0^c < \mathcal{R}_0 < 1$ is satisfied.*

The phenomenon of backward bifurcation of a system occurs when a stable disease-free equilibrium coexists with a stable endemic equilibrium under some given values for which the reproduction number is less than unity. The result of Theorem 6 implies that, while the epidemiological condition of having a reproduction number less than unity is necessary for TB elimination in the population, it is no longer sufficient. As a result, additional control measures will be necessary to control the TB epidemic. That is, the condition $\mathcal{R}_0 < \mathcal{R}_0^c < 1$ must be satisfied. It is imperative to mention that the existence of backward bifurcation can be dependent on the values of the parameter used on the system. Thus, we simulate the behavior of the active TB population with respect to effective contact rate ω and vaccine efficacy ε in Figs. 3 and 4 respectively. Figure 4 shows a bifurcation diagram of the active TB infected population in terms of the effective contact rate ω , where the value of ω ranges in $[0, 3]$. Using equation (4), we note that the effective reproduction number $\mathcal{R}_0 = 1$ when $\omega = 0.3249$. In line with Fig. 3, for $\omega \in [0, 0.3249)$, the TB-free equilibrium \mathcal{E}_0 is stable. This supports the result presented in Theorem 3. Furthermore, it can be observed that at $\omega = 0.3249$ the system exhibits a fold bifurcation such that for $\omega > 0.3249$, the stable TB-free equilibrium is exchanged for the endemic equilibrium (i.e. endemic equilibrium is stable). A similar result is observed in Fig. 4. The TB endemic equilibrium is stable for all values of $\varepsilon \in [0, 0.9626)$ and thus exchanged with the TB-free equilibrium at $\varepsilon > 0.9626$. 45

4 Numerical simulations 33

In this section, some numerical simulations are performed to confirm the previous analytical results. The influence of three important parameters is chosen based on the effect of vaccination on the density of Active of TB population $A(t)$. These parameters are the rate of vaccinating susceptible individuals (τ), the vaccine efficacy (ε), and the effective contact rate (ω). To support our simulations, the following parameter values are given. 62

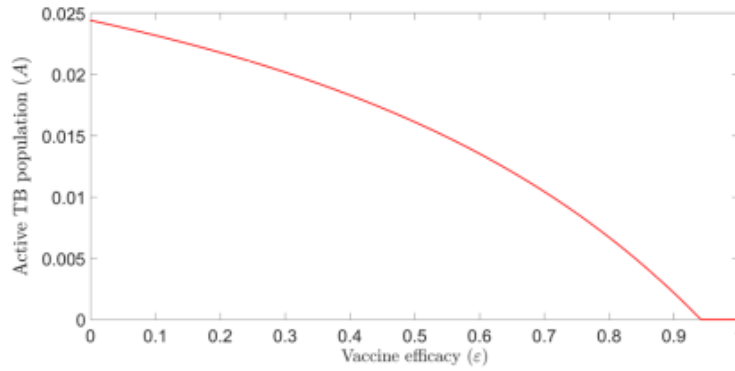

Fig. 4 Bifurcation diagram for active TB population in terms of vaccine efficacy $\varepsilon \in [0, 1]$. Parameter values used are as provided in Table 2

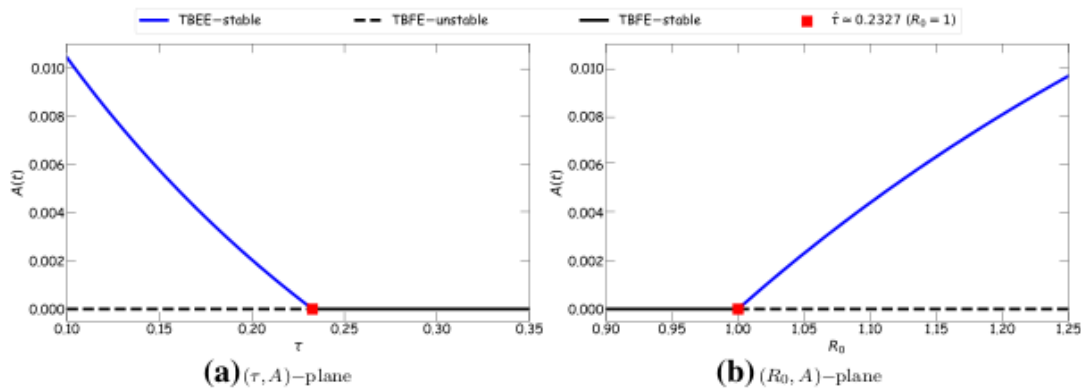

Fig. 5 Bifurcation diagram driven by τ in interval $[0.1, 0.35]$ using parameter values as in Eq. 13

$$\theta = 0.05, \rho = 0.067, \omega = 0.6501, \tau = 0.1, \varepsilon = 0.7, \gamma = 0.1, \phi = 0.01, \mu = \frac{1}{67.7}, \delta = 0.1, \beta = 0.00375. \tag{13}$$

Now, the dynamical behaviors of model 1 are investigated by varying each parameter value. In other words, we simulate the effects of different parameter values (i.e. higher and lower values) to illustrate the system’s dynamics at higher and lower parameter values.

4.1 The influence of the rate of vaccinating susceptible individuals (τ)

The influence of the rate of vaccinating susceptible individuals on the density of active TB population is numerically shown by portraying the bifurcation diagram driven by τ in the interval $0.1 \leq \tau \leq 0.35$. The numerical results is given in Fig. 5a. For $0.1 \leq \tau < \hat{\tau}$, $\hat{\tau} \approx 0.2327$, both TBFE and TBEE exist where TBFE is unstable while TBEE is asymptotically stable. When τ passes through $\hat{\tau}$, the stable TBEE disappears and TBFE becomes asymptotically stable simultaneously via forward bifurcation. Thus, $\hat{\tau}$ is confirmed as the bifurcation point. This condition holds for $\hat{\tau} < \tau \leq 0.35$. Based on the change τ , the corresponding bifurcation diagram driven by the effective

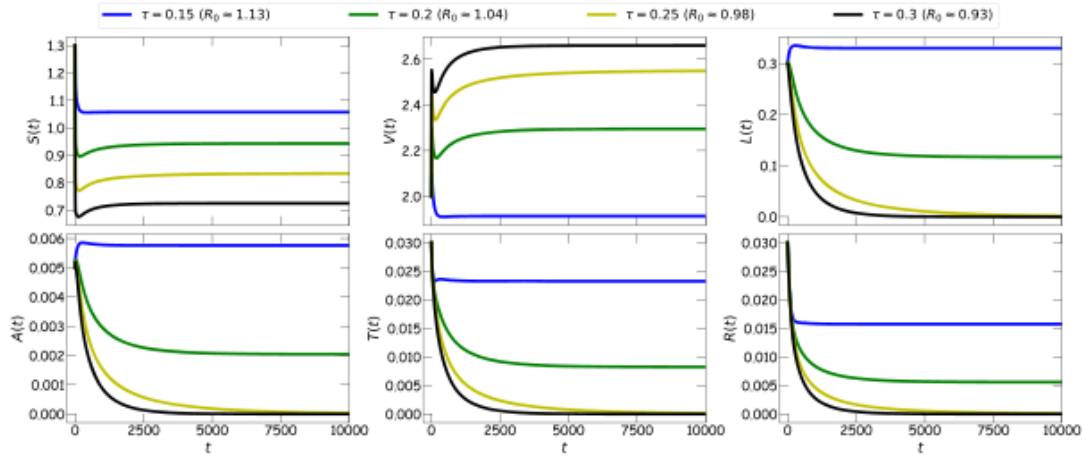

Fig. 6 Time series of TB-model (1) using parameter values as in Eq. 13 and $\tau = 0.15, 0.2, 0.25, 0.3$

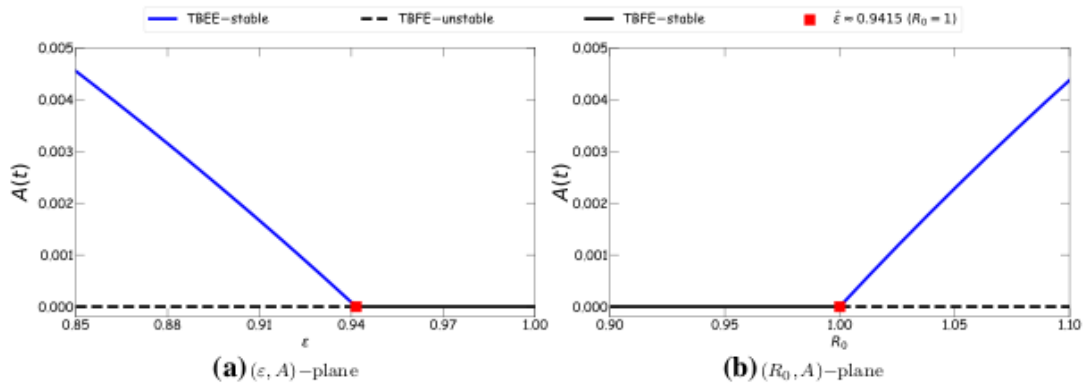

Fig. 7 Bifurcation diagram driven by ϵ in interval $[0.85, 1]$ using parameter values as in Eq. 13

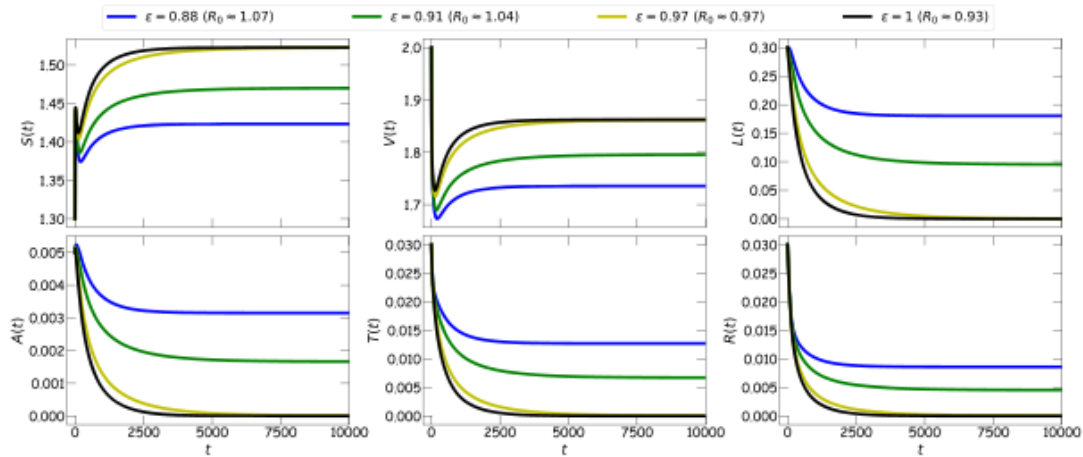

Fig. 8 Time series of TB-model (1) using parameter values as in Eq. 13 and $\epsilon = 0.88, 0.91, 0.97, 1$

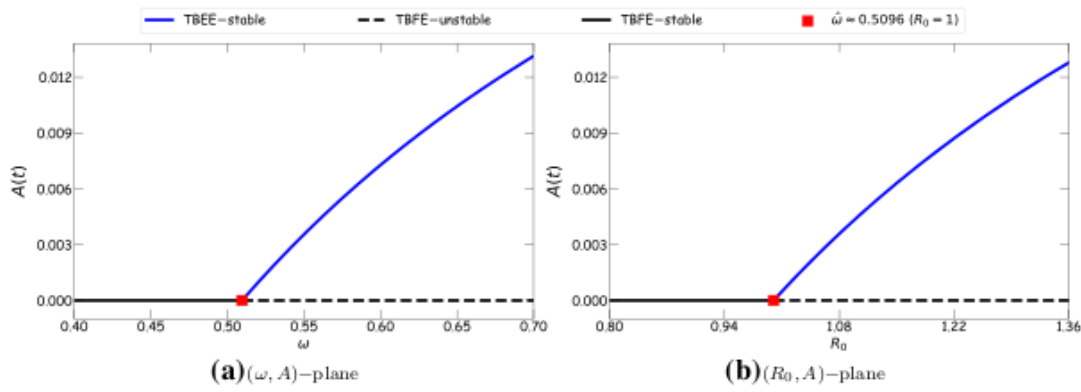

Fig. 9 Bifurcation diagram driven by ω in interval $[0.4, 0.7]$ using parameter values as in Eq. 13

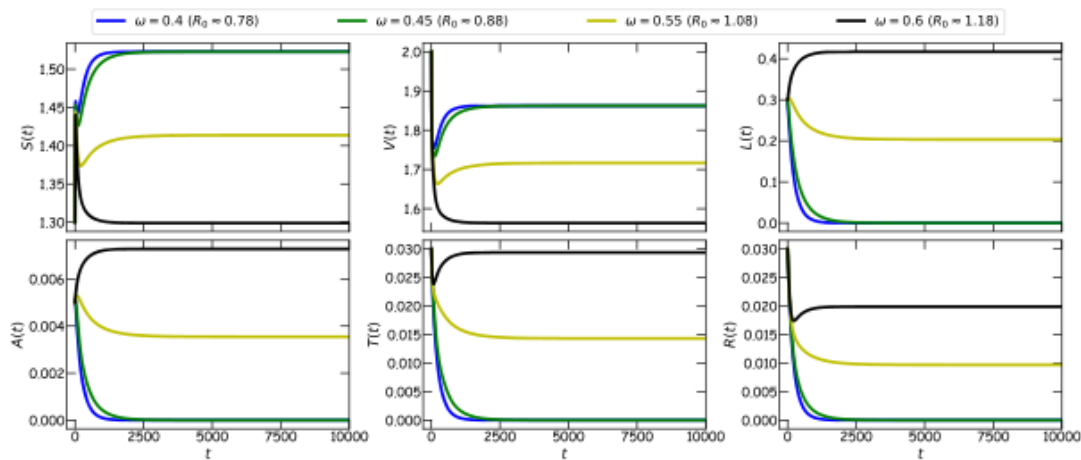

Fig. 10 Time series of TB-model (1) using parameter values as in Eq. 13 and $\omega = 0.4, 0.45, 0.55, 0.6$

reproduction number (R_0) is also plotted in Fig. 5b. We confirm that when $\tau = \hat{\tau}$, the effective reproduction number is $R_0 = 1$. When $R_0 < 1$, the density of the active TB population decreases and tends to the extinction condition. The TB population increases are directly proportional to the increases of R_0 . For example, the time series of TB model (1) for some values of τ is given in Fig. 6. From those simulations, we conclude that the rate of vaccinating susceptible individuals is inversely proportional to the density of the active TB population and the effective reproduction number. The number of active TB populations can be reduced by enhancing the rate of vaccination in susceptible individuals.

4.2 Influence of the vaccine efficacy (ε)

24

In this subsection, the parameter values is setted as in Eq. 13 and the vaccine efficacy is varied in interval $0.85 \leq \varepsilon \leq 1$. Therefore, we obtain Fig. 7a which states the bifurcation diagram driven by ε . As in Sect. 4.1, the forward bifurcation also occurs around the axial. In this respect, ε becomes the bifurcation parameter and $\hat{\varepsilon} \approx 0.9415$ is the bifurcation point. The bifurcation diagram is also shown in (R_0, A) -plane where the bifurcation point $R_0 = 1$ corresponds to $\hat{\varepsilon}$, see Fig. 7b. When $\varepsilon < \hat{\varepsilon}$ (or $R_0 < 1$),

TBEE is asymptotically stable while TBFE is a saddle point. TBEE decreases when ε increases and finally vanishes when ε crosses $\hat{\varepsilon}$ ($R_0 = 1$). To support the circumstance given by Fig. 7, the time series for $\varepsilon = 0.88, 0.91, 0.97, 0.93$ are portrayed. When $\varepsilon = 0.88, 0.91$, solutions converge to TBEE which indicate TB will eventually exists for all the time. If the vaccine efficacy $\varepsilon = 0.97, 1$, TB will becomes disappears from the population when time is moving forward. Similar with the influence of the rate of vaccinating susceptible individuals, the vaccine efficacy also inversely proportional to the density of active TB population and effective reproduction number.

4.3 Influence of the effective contact rate (ω)

To study the influence of the effective contact rate on the existence of active TB population, we still use the parameter values as in Eq. 13 and drive the value of ω as the effective contact rate parameter. The forward bifurcation also occurs for this condition which is exhibited by the bifurcation diagram given by Fig. 9a. The dynamical behavior of model (1) changes when ω crosses $\hat{\omega} \approx 0.5096$ via forward bifurcation. When $\omega < \hat{\omega}$, TBFE is the only equilibrium point of the model (1) which is asymptotically stable while TBEE does not exist. When $\omega > \hat{\omega}$, TBFE losses its stability and is accompanied by the appearance of an asymptotically stable TBEE. The suitable bifurcation diagram respect to R_0 is given in Fig. 9b where $R_0 = 1$ is attained for $\omega = \hat{\omega}$. The appropriate time series is given in Fig. 10 by setting $\omega = 0.4, 0.45, 0.55, 0.6$. When $\omega = 0.4, 0.45$, all solutions converge to TBFE while when $\omega = 0.55, 0.6$, all solutions converge to TBEE. From biological meanings, by pressing the effective contact rate, the effective reproduction number and the number of active TB will decrease.

5 Conclusions

To gain more insight into the dynamics of tuberculosis in the population, we developed a deterministic mathematical model to study the effect of vaccination on its spread and control. The developed model accounts for vaccinated individuals becoming infected as a result of using an imperfect vaccine. The model's qualitative properties were discussed, including the solution's positivity and boundedness, the biologically feasible region, the existence of equilibrium points, estimation of the threshold quantity, and the establishment of conditions for backward bifurcation possibilities. The next-generation matrix method was used to obtain the effective reproduction number \mathcal{R}_0 , which measures the average number of new secondary infections a single infected individual can reproduce during an infection period, in a population that is completely susceptible in the presence of control measure (in this case vaccination). This threshold quantity \mathcal{R}_0 is used in determining the criteria for the stability of the disease-free equilibrium, such that when $\mathcal{R}_0 < 1$, the tuberculosis-free equilibrium is said to be locally asymptotically stable and otherwise stable. The instability of the TB-free equilibrium (i.e. $\mathcal{R}_0 > 1$) indicates the existence of the TB-endemic equilibrium. The existence of the endemic equilibrium of model (1) is examined and the condi-

tions for the existence of backward bifurcation were presented. To demonstrate and support the analytical result of the study, some numerical simulations were performed to illustrate the influence of the vaccination rate τ , vaccine efficacy ε , and effective contact rate ω the density of the active tuberculosis population $A(t)$ over time. The findings show that increasing the vaccination rate of susceptible individuals reduces the disease's reproduction number, thus lowering the disease's burden. However, to effectively reduce the disease's burden, vaccine efficacy must remain above ninety-five percent. Overall, the findings indicate that reducing effective contact with an infected person and increasing the rate of vaccinating susceptible individuals with high vaccine efficacy will reduce the population's tuberculosis burden. The effect of vaccination as a disease prevention strategy was investigated in this study; however, tuberculosis can be treated after an effective infection. As a result, a future study on the impact of treatment adherence on reducing disease burden in the population will be recommended. Researchers should look into the long-term implications of the rise in drug-resistant strains, as some tuberculosis germs have been found to develop the ability to survive medications due to a variety of factors.

Author Contributions OJP conceived the idea, model formulation, OJP, MMO, EFDG, HSP, and FAO Writing, qualitative analysis, editing, proof reading.

Data availability Data used to support the findings of this study are included in the article. The authors used a set of parameter values whose sources are from the literature as shown in Table 1.

41

Declarations

Conflict of interest There are no conflicts of interest to declare.

References

1. Brian, M., Benjamin, H., Denise, K.: On treatment of tuberculosis in heterogeneous populations. *J. Theor. Biol.* **223**(4), 391–404 (2003)
2. Khajanchi, S., Das, D., Kar, T.: Dynamics of tuberculosis transmission with exogenous reinfections and endogenous reactivation. *Physica A Stat. Mech. Appl.* **497**, 52–71 (2018)
3. Bisuta, S., Kayembe, P., Kabedi, M., Situakibanza, H., Ditekemena, J., Bakebe, A., Lay, G., Mesia, G., Kayembe, J., Fueza, S.: Trends of bacteriologically confirmed pulmonary tuberculosis and treatment outcomes in democratic republic of the congo: 2007–2017. *Ann. Afr. Med.* **11**(4), 2974–2985 (2018)
4. Ullah, S., Ullah, O., Khan, M., Gul, T.: Sensitivity analysis of dengue model with saturated incidence rate. *Eur. Phys. J. Plus* **135**(602), 8–27 (2020)
5. Daniel, T.: The history of tuberculosis. *Respir. Med.* **100**(11), 1862–1870 (2006)
6. Peter, O.J., Kumar, S., Kumari, N., Oguntolu, F.A., Oshinubi, K., Musa, R.: Transmission dynamics of Monkeypox virus: a mathematical modelling approach. *Model. Earth Syst. Environ.* (2021). <https://doi.org/10.1007/s40808-021-01313-2>
7. Goufo, E., Maritz, R., Pene, M.: A mathematical and ecological analysis of the effects of petroleum oil droplets breaking up and spreading in aquatic environments. *Int. J. Environ. Pollut.* **61**(1), 64–71 (2017)
8. Atangana, A., Goufo, E.F.D.: Computational analysis of the model describing HIV infection of CD4+ T cells. *BioMed Res. Int.* **2014**, 1–7 (2014)
9. Djomegni, P., Govinder, E., Goufo, K.: Movement, competition and pattern formation in a two prey–one predator food chain model. *Comput. Appl. Math.* **37**, 2445–2459 (2018)

10. Peter, O.J., Yusuf, A., Oshinubi, K., Oguntolu, F.A., Lawal, J.O., Abioye, A.I., Ayoola, T.A.: Fractional order of pneumococcal pneumonia infection model with Caputo Fabrizio operator. *Results Phys.* **29**, 104581 (2021)
11. Atangana, A., Qureshi, S.: Mathematical modeling of an autonomous nonlinear dynamical system for malaria transmission using Caputo derivative. In: Akdemir, A.O., Dutta, H., Atangana, A. (eds.) *Fractional order analysis: theory, methods and applications*, pp. 225–252. Wiley, Hoboken (2020)
12. Peter, O.J., Shaikh, A.S., Ibrahim, M.O., Nisar, K.S., Baleanu, D., Khan, I., Abioye, A.I.: Analysis and dynamics of fractional order mathematical model of Covid-19 in Nigeria using Atangana-Baleanu operator. *Comput. Mater. Continua* **66**, 1823–1848 (2021)
13. Peter, O.J., Qureshi, S., Yusuf, A., Al-Shomrani, M., Idowu, A.A.: A new mathematical model of Covid-19 using real data from Pakistan. *Results Phys.* **24**, 104098 (2021)
14. Khan, H., Gómez-Aguilar, J., Alkhazzan, A., Khan, A.: A fractional order HIV-TB coinfection model with nonsingular Mittag-Leffler law. *Math. Methods Appl. Sci.* **43**(6), 3786–3806 (2020)
15. Akinpelu, F., Ojo, M.: Mathematical analysis of effect of isolation on the transmission of Ebola virus disease in a population. *Asian Res. J. Math.* **1**, 1–12 (2016)
16. Ahmad, S., Ullah, A., Al-Mdallal, Q.M., Khan, H., Shah, K., Khan, A.: Fractional order mathematical modeling of Covid-19 transmission. *Chaos Solitons Fractals* **139**, 110256 (2020)
17. Arafa, A., Khalil, M., Sayed, A.: A non-integer variable order mathematical model of human immunodeficiency virus and malaria coinfection with time delay. *Complexity* **2019**, 1–13 (2019)
18. Ojo, M.M., Goufo, E.F.D.: Modeling, analyzing and simulating the dynamics of Lassa fever in Nigeria. *J. Egypt. Math. Soc.* **30**(1), 1–31 (2022)
19. Demongeot, J., Griette, Q., Magal, P., Webb, G.: Modeling vaccine efficacy for Covid-19 outbreak in New York city. *Biology* **11**(3), 345 (2022)
20. Musa, S.S., Qureshi, S., Zhao, S., Yusuf, A., Mustapha, U.T., He, D.: Mathematical modeling of Covid-19 epidemic with effect of awareness programs. *Infect. Dis. Model.* **6**, 448–460 (2021)
21. Memon, Z., Qureshi, S., Memon, B.R.: Assessing the role of quarantine and isolation as control strategies for Covid-19 outbreak: a case study. *Chaos Solitons Fractals* **144**, 110655 (2021)
22. Mustapha, U., Hincal, E., Yusuf, A., Qureshi, S., Sanlidag, T., Muhammad, S., Kaymakzade, B., Gokbulut, N.: Transmission dynamics and control strategies of Covid-19: a modelling study. **2**, 92–105 (2021)
23. Yang, Y., Li, J., Ma, Z., Liu, L.: Global stability of two models with incomplete treatment for tuberculosis. *Chaos Solitons Fractals* **43**, 79–85 (2010)
24. Zhang, J., Liand, Y., Zhang, X.: Mathematical modeling of tuberculosis data of china. *Chaos Solitons Fractals* **365**, 159–163 (2015)
25. Egonmwan, A., Okuonghae, D.: Mathematical analysis of a tuberculosis model with imperfect vaccine. *Int. J. Biomath.* **13**, 26–42 (2019)
26. Ullah, I., Ahmad, Q., Al-Mdallal, S., Khan, Z., Khan, H., Khan, A.: Stability analysis of a dynamical model of tuberculosis with incomplete treatment. *Adv. Differ. Equ.* **2020**(1), 1–14 (2020)
27. Intan, S., Sriwahyuni, Vera, H., Syarifah, M., Taufiq, I.R., Marwan, R.: The epidemic of tuberculosis on vaccinated population. *J. Phys. Conf. Ser.* **890**, 012017 (2017)
28. Okuonghae, D.: A mathematical model of tuberculosis transmission with heterogeneity in disease susceptibility and progression under a treatment regime for infectious cases. *Appl. Math. Model.* **37**(10), 6786–6808 (2013)
29. Liu, J., Zhang, T.: Global stability for a tuberculosis model. *Math. Comput. Model.* **54**(1), 836–845 (2011)
30. Andrawus, J., Eguda, F., Usman, I., Maiwa, S., Dibal, I., Urum, T., Anka, G.: A mathematical model of a tuberculosis transmission dynamics incorporating first and second line treatment. *J. Appl. Sci. Environ. Manag.* **24**(5), 917–922 (2020)
31. Selain, K., Emile, F., Vinh, H.: Analysis and simulation of a mathematical model of tuberculosis transmission in Democratic Republic of the Congo. *Adv. Differ. Equ.* **642**, 1–19 (2020)
32. Kim, S., de los Reyes, V.A.A., Jung, E.: Country-specific intervention strategies for top three TB burden countries using mathematical model. *PLoS ONE* **15**(4), 0230964 (2020)
33. Nkamba, L., Manga, F., Agouanet, T.T., Manyombe, M.: Mathematical model to assess vaccination and effective contact rate impact in the spread of tuberculosis. *J. Biol. Dyn.* **13**(1), 26–42 (2019)
34. Gerberry, D.: Practical aspects of backward bifurcation in a mathematical model for tuberculosis. *J. Theor. Biol.* **388**, 15–36 (2016)

35. Ludji, D., Sianturi, P., Nugrahani, E.: Dynamical system of the mathematical model for tuberculosis with vaccination. *Comput. Math. Eng. Appl.* **10**(2), 59–66 (2019)
36. Mishra, B., Srivastava, J.: Mathematical model on pulmonary and multidrug-resistant tuberculosis patients with vaccination. *J. Egypt. Math. Soc.* **22**(2), 311–316 (2014)
37. Wangari, I., Davis, S., Stone, L.: Backward bifurcation in epidemic models: problems arising with aggregated bifurcation parameters. *Appl. Math. Model.* **40**(2), 1669–1675 (2019)
38. Nguipdop-Djomo, P., Heldal, E., Rodrigues, L., Abubakar, P., Mangtani, I.: Duration of BCG protection against tuberculosis and change in effectiveness with time since vaccination in Norway: a retrospective population-based cohort study. *Lancet* **16**, 219–226 (2016)
39. Alexander, M., Moghadas, S., Rohani, P., Summers, A.: Modelling the effect of a booster vaccination on disease epidemiology. *J. Math. Biol.* **52**, 290–306 (2006)
40. Aronson, N., Santosham, G., Comstock, M., Howard, R., Moulton, L., Rhoades, E., Harrison, L.: Long-term efficacy of BCG vaccine in American Indians and Alaska natives: a 60-year follow-up study. *JAMA* **291**, 2086–2091 (2004)
41. Steme, J., Rodrigues, L., Guedes, I.: Does the efficacy of BCG decline with time since vaccination. *Int. J. Tuberc. Lung Dis.* **2**, 200–207 (1998)
42. Nkamba, L., Manga, T., Agouanet, F., MannManyombe, M.: Mathematical model to assess vaccination and effective contact rate impact in the spread of tuberculosis. *J. Biol. Dyn.* **13**, 26–42 (2019)
43. Colditz, G.A., Brewer, T.F., Berkey, C.S., Wilson, M.E., Burdick, E., Fineberg, H.V., Mosteller, F.: Efficacy of BCG vaccine in the prevention of tuberculosis: meta-analysis of the published literature. *JAMA* **271**(9), 698–702 (1994)
44. Sulayman, F., Abdullah, F.A., Mohd, M.H.: An Sveire model of tuberculosis to assess the effect of an imperfect vaccine and other exogenous factors. *Mathematics* **9**(4), 327 (2021)
45. Ojo, M., Akinpelu, F.: Lyapunov functions and global properties of seir epidemic model. *Int. J. Chem. Math. Phys.* **1**(1), 11–16 (2017)
46. Ojo, M.M., Gbadamosi, B., Benson, T.O., Adebimpe, O., Georgina, A.: Modeling the dynamics of Lassa fever in Nigeria. *J. Egypt. Math. Soc.* **29**(1), 1–19 (2021)
47. Oke, S.I., Ojo, M.M., Adeniyi, M.O., Matadi, M.B.: Mathematical modeling of malaria disease with control strategy. *Commun. Math. Biol. Neurosci.* **2020** (2020)
48. Diekmann, O., Heesterbeek, J.A.P., Metz, J.A.: On the definition and the computation of the basic reproduction ratio R_0 in models for infectious diseases in heterogeneous populations. *J. Math. Biol.* **28**(4), 365–382 (1990)
49. Gumel, A.B., McCluskey, C.C., Watmough, J.: An SVEIR model for assessing potential impact of an imperfect anti-SARS vaccine. *Math. Biosci. Eng.* **3**(3), 485 (2006)
50. Akinpelu, F., Ojo, M.: A mathematical model for the dynamic spread of infection caused by poverty and prostitution in Nigeria. *Int. J. Math. Phys. Sci. Res.* **4**, 33–47 (2016)
51. Goufo, E.F.D., Pene, M.K., Mugisha, S.: Stability analysis of epidemic models of Ebola hemorrhagic fever with non-linear transmission. *J. Nonlinear Sci. Appl. (JNSA)* **9**(6), 4191–4205 (2016)
52. Peter, O.J., Abioye, A.I., Oguntolu, F.A., Owolabi, T.A., Ajisope, M.O., Zakari, A.G., Shaba, T.G.: Modelling and optimal control analysis of Lassa fever disease. *Inform. Med. Unlocked* **20**, 100419 (2020)
53. Gbadamosi, B., Ojo, M.M., Oke, S.I., Matadi, M.B.: Qualitative analysis of a dengue fever model. *Math. Comput. Appl.* **23**(3), 33 (2018)
54. Ojo, M.M., Goufo, E.F.D.: Assessing the impact of control interventions and awareness on malaria: a mathematical modeling approach. *Commun. Math. Biol. Neurosci.* **2021** (2021)
55. Van den Driessche, P., Watmough, J.: Reproduction numbers and sub-threshold endemic equilibria for compartmental models of disease transmission. *Math. Biosci.* **180**(1–2), 29–48 (2002)
56. Anguelov, R., Garba, S.M., Usaini, S.: Backward bifurcation analysis of epidemiological model with partial immunity. *Comput. Math. Appl.* **68**(9), 931–940 (2014)
57. Huo, J., Zhao, H., Zhu, L.: The effect of vaccines on backward bifurcation in a fractional order HIV model. *Nonlinear Anal. Real World Appl.* **26**, 289–305 (2015)
58. Chen, X., Fu, F.: Imperfect vaccine and hysteresis. *Proc. R. Soc. B* **286**(1894), 20182406 (2019)

Mathematical model for control of tuberculosis epidemiology

ORIGINALITY REPORT

20%

SIMILARITY INDEX

10%

INTERNET SOURCES

15%

PUBLICATIONS

8%

STUDENT PAPERS

PRIMARY SOURCES

| | | |
|---|---|-----|
| 1 | Submitted to Saint Stephen's College Student Paper | 1% |
| 2 | www.ijlemr.com Internet Source | 1% |
| 3 | Lili Han, Qiuhui Pan, Baolin Kang, Mingfeng He. "Effects of masks on the transmission of infectious diseases", Advances in Difference Equations, 2021 Publication | 1% |
| 4 | Submitted to Flinders University Student Paper | 1% |
| 5 | Submitted to Fiji National University Student Paper | 1% |
| 6 | Obiora Cornelius Collins, Kevin Jan Duffy. "Using Data of a Lassa Fever Epidemic in Nigeria: A Mathematical Model Is Shown to Capture the Dynamics and Point to Possible Control Methods", Mathematics, 2023 Publication | 1% |
| 7 | Lin Li, Zhong Chen. "A meshless method for solving nonlinear variable-order fractional Ginzburg–Landau equations on arbitrary domains", Journal of Applied Mathematics and Computing, 2022 Publication | 1% |
| 8 | Submitted to University of Brighton Student Paper | <1% |

| | | |
|----|---|------|
| 9 | Pushpendra Kumar, Vedat Suat Erturk, Marina Murillo-Arcila. "A new fractional mathematical modelling of COVID-19 with the availability of vaccine", Results in Physics, 2021 Publication | <1 % |
| 10 | Shambhu N. Sharma. "Non-linear filtering for a dust-perturbed two-body model", Nonlinear Dynamics, 02/2009 Publication | <1 % |
| 11 | Submitted to Jersey College Student Paper | <1 % |
| 12 | Suvankar Majee, Soovoojeet Jana, Snehasis Barman, T K Kar. "Transmission dynamics of monkeypox virus with treatment and vaccination controls: a fractional order mathematical approach", Physica Scripta, 2023 Publication | <1 % |
| 13 | Submitted to West Coast University Student Paper | <1 % |
| 14 | www.scik.org Internet Source | <1 % |
| 15 | Fatima Sulayman, Farah Aini Abdullah. "Analysis of a Tuberculosis Infection Model considering the Influence of Saturated Recovery (Treatment)", Complexity, 2021 Publication | <1 % |
| 16 | zenodo.org Internet Source | <1 % |
| 17 | Submitted to Lehigh University Student Paper | <1 % |
| 18 | Olumuyiwa James Peter, Sania Qureshi, Abdullahi Yusuf, Mohammed Al-Shomrani, Abioye Abioye Idowu. "A new mathematical | <1 % |

model of COVID-19 using real data from
Pakistan", Results in Physics, 2021

Publication

19

Victor Moreno, Baltazar Espinoza, Kamal Barley, Marlio Paredes, Derdei Bichara, Anuj Mubayi, Carlos Castillo-Chavez. "The role of mobility and health disparities on the transmission dynamics of Tuberculosis", Theoretical Biology and Medical Modelling, 2017

Publication

<1 %

20

Zhou, X.-y.. "Global results for a cholera model with imperfect vaccination", Journal of the Franklin Institute, 201204

Publication

<1 %

21

journals.sagepub.com

Internet Source

<1 %

22

Hao Wang, Silogini Thanarajah, Philippe Gaudreau. "Refuge-mediated predator-prey dynamics and biomass pyramids", Mathematical Biosciences, 2018

Publication

<1 %

23

Berat Karaagac, Kolade M. Owolabi. "Numerical analysis of polio model: A mathematical approach to epidemiological model using derivative with Mittag-Leffler Kernel", Mathematical Methods in the Applied Sciences, 2021

Publication

<1 %

24

Enomoto, Y.. "Monte Carlo simulation study on reorganization energy of electron-transfer reactions in polar solution", Chemical Physics Letters, 19910322

Publication

<1 %

25

Nainggolan, J, Sudradjat Supian, A K Supriatna, and N Anggriani. "Mathematical

<1 %

Model Of Tuberculosis Transmission With Reccurent Infection And Vaccination", Journal of Physics Conference Series, 2013.

Publication

26

iieta.org
Internet Source

<1 %

27

www.ncbi.nlm.nih.gov
Internet Source

<1 %

28

Zaibunnisa Memon, Sania Qureshi, Bisharat Rasool Memon. "Assessing the role of quarantine and isolation as control strategies for COVID-19 outbreak: A case study", Chaos, Solitons & Fractals, 2021

Publication

<1 %

29

Ian B. Augsburger, Grace K. Galanthay, Jacob H. Tarosky, Jan Rychtář, Dewey Taylor. "Voluntary vaccination may not stop monkeypox outbreak: A game-theoretic model", PLOS Neglected Tropical Diseases, 2022

Publication

<1 %

30

Submitted to Rowan University
Student Paper

<1 %

31

S. Olaniyi, M. Mukamuri, K.O. Okosun, O.A. Adepoju. "Mathematical analysis of a social hierarchy-structured model for malaria transmission dynamics", Results in Physics, 2022

Publication

<1 %

32

Subhas Khajanchi, Kankan Sarkar, Jayanta Mondal, Kottakkaran Sooppy Nisar, Sayed F. Abdelwahab. "Mathematical modeling of the COVID-19 pandemic with intervention strategies", Results in Physics, 2021

Publication

<1 %

| | | |
|----|---|------|
| 33 | Submitted to Zewail City of Science and Technology Student Paper | <1 % |
| 34 | Abhishek Kumar, Nilam. "Effects of Nonmonotonic Functional Responses on a Disease Transmission Model: Modeling and Simulation", Communications in Mathematics and Statistics, 2021 Publication | <1 % |
| 35 | www.akamaiuniversity.us Internet Source | <1 % |
| 36 | Submitted to Ashesi University Student Paper | <1 % |
| 37 | Ibrahim M. Hezam, Abdelaziz Foul, Adel Alrasheedi. "A dynamic optimal control model for COVID-19 and cholera co-infection in Yemen", Advances in Difference Equations, 2021 Publication | <1 % |
| 38 | Submitted to Massasoit Community College Student Paper | <1 % |
| 39 | Patrick M. Tchepmo Djomegni, Emile F. DOUNGMO GOUFO, Subrata K. Sahu, Mohamed Mbehou. "Coexistence and harvesting control policy in a food chain model with mutual defense of prey", Natural Resource Modeling, 2019 Publication | <1 % |
| 40 | Submitted to University of Warwick Student Paper | <1 % |
| 41 | repository.uwc.ac.za Internet Source | <1 % |
| 42 | www.openj-gate.com Internet Source | <1 % |

| | | |
|----|---|------|
| 43 | www.intechopen.com Internet Source | <1 % |
| 44 | www.techscience.com Internet Source | <1 % |
| 45 | www.up.ac.za Internet Source | <1 % |
| 46 | Attiq ul Rehman, Ram Singh, Praveen Agarwal. "Modeling, analysis and prediction of new variants of covid-19 and dengue co-infection on complex network", Chaos, Solitons & Fractals, 2021 Publication | <1 % |
| 47 | D. Baleanu, M. Hassan Abadi, A. Jajarmi, K. Zarghami Vahid, J.J. Nieto. "A new comparative study on the general fractional model of COVID-19 with isolation and quarantine effects", Alexandria Engineering Journal, 2021 Publication | <1 % |
| 48 | O.K. Koriko, T.T. Yusuf. "Mathematical Model to Simulate Tuberculosis Disease Population Dynamics", American Journal of Applied Sciences, 2008 Publication | <1 % |
| 49 | Selain Kasereka Kabunga, Emile F. Doungmo Goufo, Vinh Ho Tuong. "Analysis and simulation of a mathematical model of tuberculosis transmission in Democratic Republic of the Congo", Advances in Difference Equations, 2020 Publication | <1 % |
| 50 | ebin.pub Internet Source | <1 % |
| 51 | ena.lp.edu.ua Internet Source | <1 % |

52 go.gale.com Internet Source <1 %

53 www.corydondemocrat.com Internet Source <1 %

54 zagan.unizar.es Internet Source <1 %

55 Ihsan Ullah, Saeed Ahmad, Mati ur Rahman, Muhammad Arfan. "Investigation of fractional order tuberculosis (TB) model via Caputo derivative", Chaos, Solitons & Fractals, 2020
Publication <1 %

56 Rubayyi T. Alqahtani, Salihu S. Musa, Abdullahi Yusuf. "Using epidemiological modelling to unravel the dynamics of the COVID-19 pandemic with the effect of vaccination, vertical transmission and hospitalization", Results in Physics, 2022
Publication <1 %

57 Sayooj Aby Jose, Raja Ramachandran, Dumitru Baleanu, Hasan S. Panigoro, Jehad Alzabut, Valentina E. Balas. "Computational dynamics of a fractional order substance addictions transfer model with Atangana - Baleanu - Caputo derivative", Mathematical Methods in the Applied Sciences, 2022
Publication <1 %

58 Zhe DUAN, Baojun DU, Jiangang ZHANG. "Application of Promotion Process Based on Epidemic Models Considering Bidirectionality", Wuhan University Journal of Natural Sciences, 2022
Publication <1 %

59 banglajol.info Internet Source <1 %

dspace.biruni.edu.tr

| | | |
|----|--|------|
| 60 | Internet Source | <1 % |
| 61 | journals.plos.org Internet Source | <1 % |
| 62 | matematika.utm.my Internet Source | <1 % |
| 63 | ouci.dntb.gov.ua Internet Source | <1 % |
| 64 | "Computational Sciences - Modelling, Computing and Soft Computing", Springer Science and Business Media LLC, 2021 Publication | <1 % |
| 65 | Allen, L.J.S.. "The dynamics of two viral infections in a single host population with applications to hantavirus", Mathematical Biosciences, 200312 Publication | <1 % |
| 66 | Bruno Buonomo. "Analysis of a tuberculosis model with a case study in Uganda", Journal of Biological Dynamics, 2010 Publication | <1 % |
| 67 | Dennis S. Keeler, Leiba Rodman, Ilya M. Spitkovsky. "The numerical range of 3×3 matrices", Linear Algebra and its Applications, 1997 Publication | <1 % |
| 68 | G.P. Samanta. "Analysis of a delayed hand-foot-mouth disease epidemic model with pulse vaccination", Systems Science & Control Engineering, 2014 Publication | <1 % |
| 69 | Idris Ahmed, Isa Abdullahi Baba, Abdullahi Yusuf, Poom Kumam, Wiyada Kumam. "Analysis of Caputo fractional-order model for | <1 % |

COVID-19 with lockdown", Advances in Difference Equations, 2020

Publication

70

Julien Arino. "Effect of pathogen-resistant vectors on the transmission dynamics of a vector-borne disease", Journal of Biological Dynamics, 10/2007

Publication

<1 %

71

Khadija Akdim, Adil Ez-Zetouni, Mehdi Zahid. "The influence of awareness campaigns on the spread of an infectious disease: a qualitative analysis of a fractional epidemic model", Modeling Earth Systems and Environment, 2021

Publication

<1 %

72

Muntaser Safan, Kamal Barley, Mohamed M. Elhaddad, Mohamed A. Darwish, Samir H. Saker. "Mathematical Analysis of an SIVRWS Model for Pertussis with Waning and Naturally Boosted Immunity", Symmetry, 2022

Publication

<1 %

73

discovery.ucl.ac.uk

Internet Source

<1 %

74

kb.psu.ac.th

Internet Source

<1 %

75

pure.rug.nl

Internet Source

<1 %

76

www.hjms.hacettepe.edu.tr

Internet Source

<1 %

77

www.matbio.org

Internet Source

<1 %

78

Ángel G. C. Pérez, David A. Oluyori. "An extended SEIARD model for COVID-19

<1 %

vaccination in Mexico: analysis and forecast",
Cold Spring Harbor Laboratory, 2021

Publication

79

"Applications of Fluid Dynamics", Springer
Science and Business Media LLC, 2018

Publication

<1 %

80

Arshad Alam Khan, Saif Ullah, Rohul Amin.
"Optimal control analysis of COVID-19 vaccine
epidemic model: a case study", The European
Physical Journal Plus, 2022

Publication

<1 %

81

Olumuyiwa James Peter, Abdullahi Yusuf,
Kayode Oshinubi, Festus Abiodun Oguntolu et
al. "Fractional order of pneumococcal
pneumonia infection model with Caputo
Fabrizio operator", Results in Physics, 2021

Publication

<1 %

82

Qian Jiang, Zhijun Liu, Lianwen Wang,
Ronghua Tan. "A tuberculosis model with
early and late latency, imperfect vaccination,
and relapse: An application to China",
Mathematical Methods in the Applied
Sciences, 2023

Publication

<1 %

83

Suvankar Majee, Soovoojeet Jana, Snehasis
Barman, Tapan Kumar Kar. "Transmission
Dynamics of Monkeypox Virus with Treatment
and Vaccination Controls: A Fractional Order
Mathematical Approach", Physica Scripta,
2022

Publication

<1 %

Exclude quotes On

Exclude matches Off

Exclude bibliography On